



Standardised “EN 733” centrifugal pumps

-  Clean water
-  Industrial use



PERFORMANCE RANGE

- Flow rate up to **6000 l/min** (360 m³/h)
- Head up to **98 m**

APPLICATION LIMITS

- Manometric suction lift up to **7 m**
- Liquid temperature between **-10 °C** and **+90 °C**
- Max. pressure in pump body **10 bar** (PN10)

CONSTRUCTION AND SAFETY STANDARDS

EN 733



CERTIFICATIONS

Company with management system certified DNV
ISO 9001: QUALITY

INSTALLATION AND USE

- Water supply
- Pressure boosting
- Irrigation
- Water circulation in air-conditioning units
- Cleaning sets
- Firefighting sets
- Industrial applications
- Agricultural applications

OPTIONS AVAILABLE ON REQUEST

- Counter flange KIT complete with bolts, nuts and washers
- Special mechanical seal
- Compatibility with hotter or colder liquids
- Compatibility with hotter or colder environments

GUARANTEE

2 years subject to terms and conditions

PERFORMANCE RANGE

n = 3450 min⁻¹

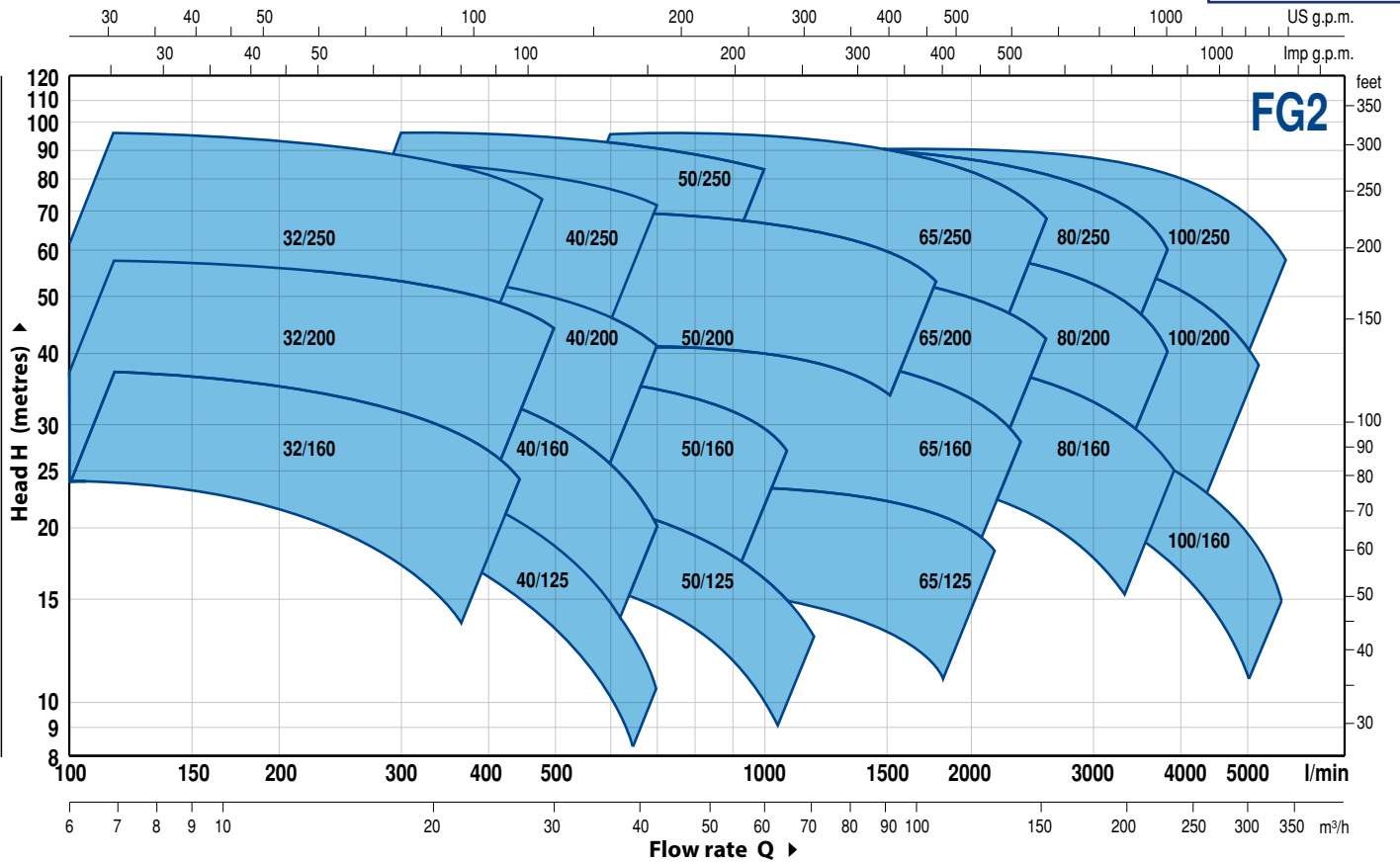

PERFORMANCE DATA

MODEL	MOTOR PAIRING		PERFORMANCE n = 3450 min ⁻¹	
	kW	HP	Q m ³ /h	H metres
FG2-32/160C	1.5	2	6 – 21	24 – 14
FG2-32/160B	2.2	3	6 – 24	30 – 17
FG2-32/160A	3	4	6 – 27	37 – 24
FG2-32/200C	4	5.5	6 – 27	44 – 31.5
FG2-32/200B	5.5	7.5	6 – 30	51 – 36
FG2-32/200A	7.5	10	6 – 30	57 – 44
FG2-32/200BH	3	4	6 – 18	45 – 37
FG2-32/200AH	4	5.5	6 – 19.2	55 – 44
FG2-32/250C	9.2	12.5	6 – 27	75 – 60
FG2-32/250B	11	15	6 – 30	87 – 70
FG2-32/250A	15	20	6 – 30	97 – 80
FG2-40/125C	1.1	1.5	6 – 33	16 – 6
FG2-40/125B	1.5	2	6 – 36	20.5 – 9
FG2-40/125A	2.2	3	6 – 42	26 – 10
FG2-40/160C	2.2	3	6 – 36	27 – 14
FG2-40/160B	3	4	6 – 36	32 – 20
FG2-40/160A	4	5.5	6 – 42	38 – 20
FG2-40/200B	5.5	7.5	6 – 42	47 – 28
FG2-40/200A	7.5	10	6 – 42	55 – 41
FG2-40/250C	9.2	12.5	6 – 42	64 – 47
FG2-40/250B	11	15	6 – 42	71 – 55
FG2-40/250A	15	20	6 – 42	88 – 72
FG2-50/125C	2.2	3	18 – 72	17.5 – 6
FG2-50/125B	3	4	18 – 72	20.7 – 9
FG2-50/125A	4	5.5	18 – 72	23.5 – 13
FG2-50/160C	4	5.5	18 – 60	27 – 16
FG2-50/160B	5.5	7.5	18 – 66	32 – 21
FG2-50/160A	7.5	10	18 – 66	37 – 27
FG2-50/200C	11	15	24 – 102	44 – 30
FG2-50/200B	15	20	24 – 102	52 – 38
FG2-50/200A	18.5	25	24 – 108	61 – 45
FG2-50/200AR	22	30	24 – 108	69 – 53
FG2-50/250D	9.2	12.5	18 – 54	51 – 32
FG2-50/250C	11	15	18 – 54	59 – 42
FG2-50/250B	15	20	18 – 60	72 – 59
FG2-50/250A	18.5	25	18 – 60	85 – 73
FG2-50/250AR	22	30	18 – 60	95 – 83

MODEL	MOTOR PAIRING		PERFORMANCE n = 3450 min ⁻¹	
	kW	HP	Q m ³ /h	H metres
FG2-65/125C	4	5.5	36 – 108	16 – 11
FG2-65/125B	5.5	7.5	36 – 120	18 – 13
FG2-65/125A	7.5	10	36 – 132	23 – 18
FG2-65/160C	9.2	12.5	36 – 132	32 – 22
FG2-65/160B	11	15	36 – 144	36.5 – 23
FG2-65/160A	15	20	36 – 144	40.5 – 28
FG2-65/200B	15	20	12 – 144	44 – 30.5
FG2-65/200A	18.5	25	12 – 150	50 – 36.5
FG2-65/200AR	22	30	12 – 156	57 – 42
FG2-65/250C	30	40	24 – 141	76 – 53
FG2-65/250B	37	50	24 – 150	87 – 62
FG2-65/250A	45	60	24 – 156	95 – 68
FG2-80/160D	11	15	30 – 240	25 – 10
FG2-80/160C	15	20	30 – 240	30 – 15
FG2-80/160B	18.5	25	30 – 240	35 – 20
FG2-80/160A	22	30	30 – 240	40 – 25
FG2-80/200B	30	40	30 – 219	56 – 34.5
FG2-80/200A	37	50	30 – 234	62 – 40
FG2-80/250B	45	60	36 – 216	77 – 54
FG2-80/250A	55	75	36 – 234	88.5 – 60
FG2-100/160A	22	30	60 – 360	35 – 15
FG2-100/200C	30	40	48 – 279	51 – 28
FG2-100/200B	37	50	48 – 294	57 – 33
FG2-100/200A	45	60	48 – 315	63 – 38
FG2-100/250B	55	75	48 – 309	75 – 48
FG2-100/250A	75	100	48 – 345	89 – 58

Q = Flow rate

H = Total manometric head

Tolerance of characteristic curves in compliance with EN ISO 9906 Grade 3B.

FG2

CHARACTERISTIC CURVES

$n = 3450 \text{ min}^{-1}$

FG2-32/160

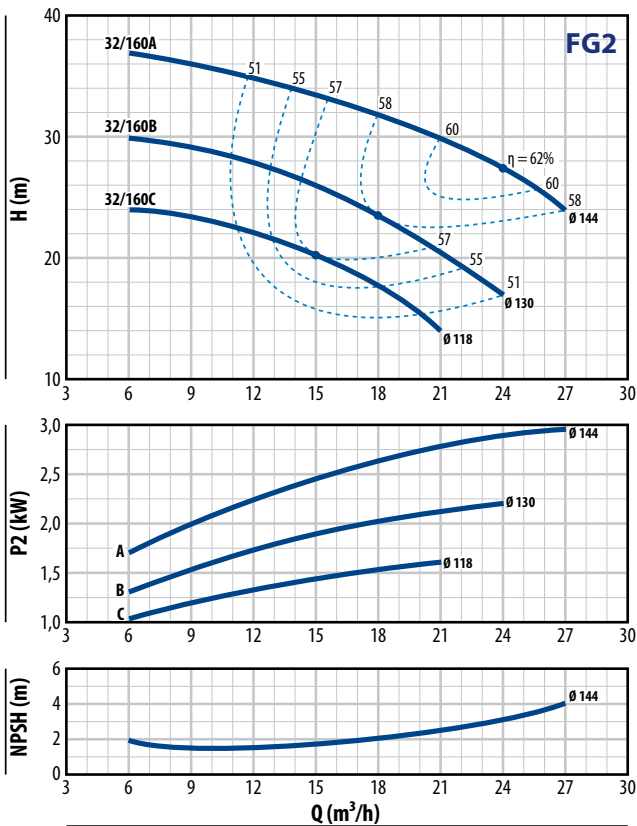

FG2-32/200

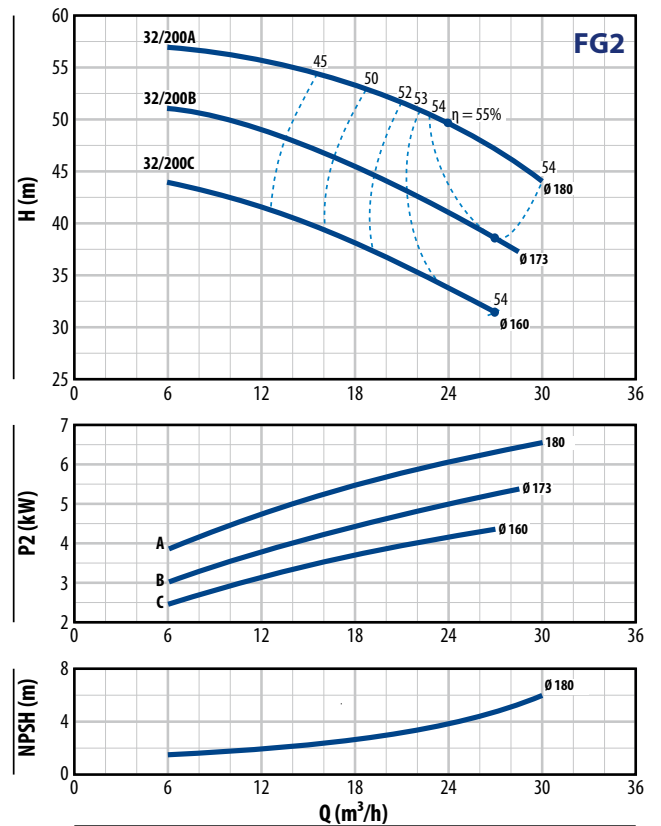

FG2-32/200H

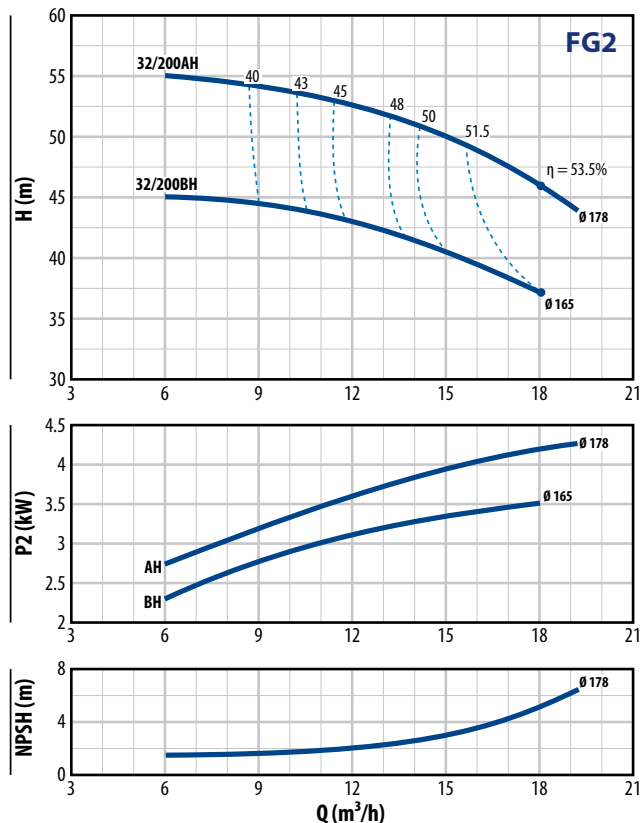

FG2-32/250

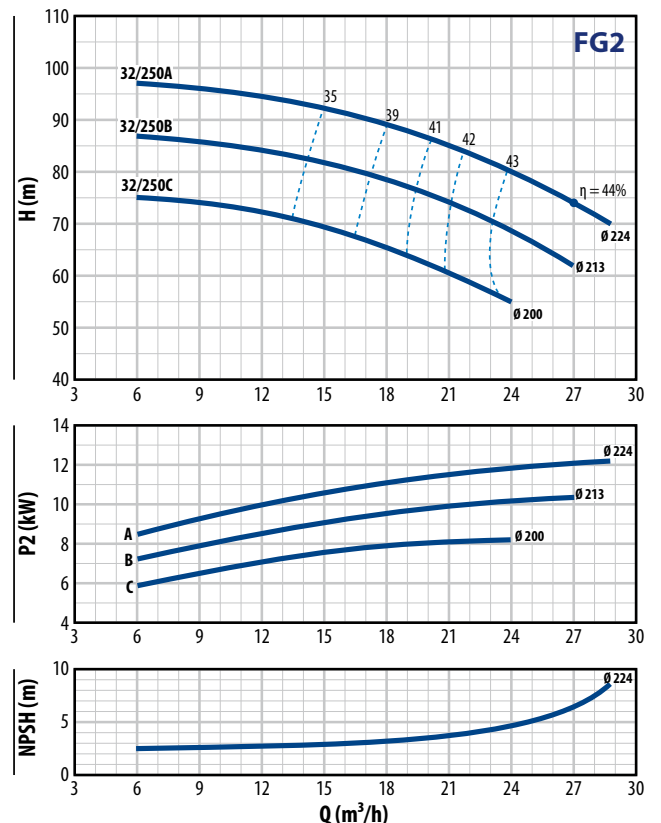

CHARACTERISTIC CURVES

$n = 3450 \text{ min}^{-1}$

FG2-40/125

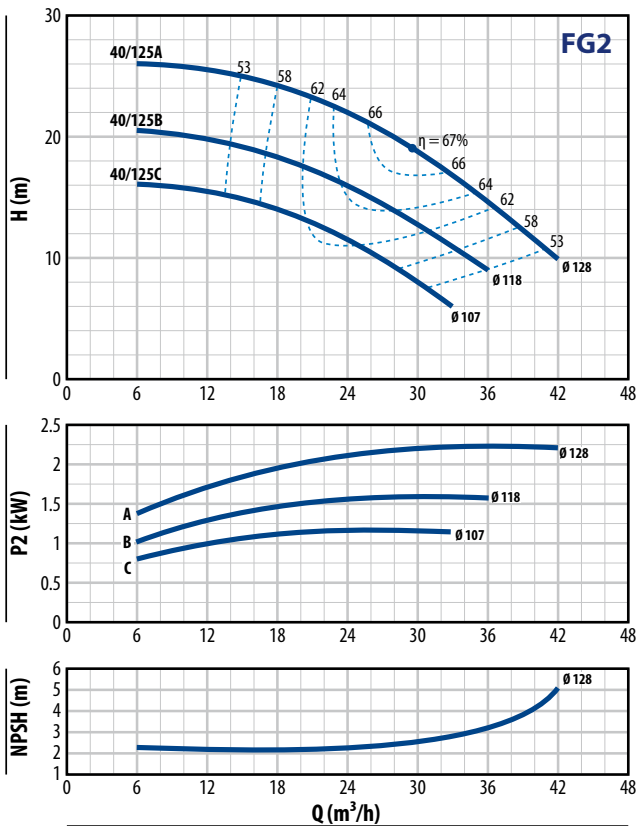

FG2-40/160

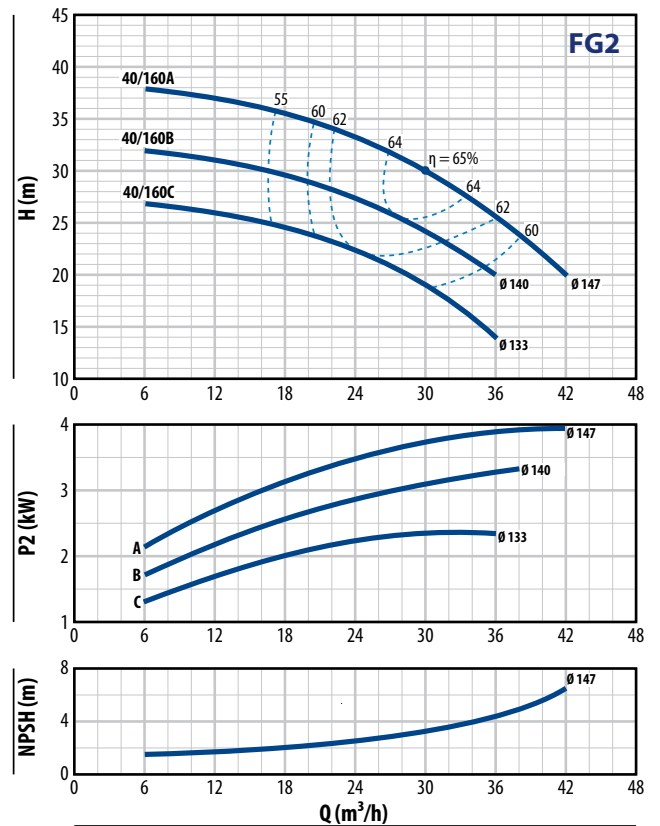

FG2-40/200

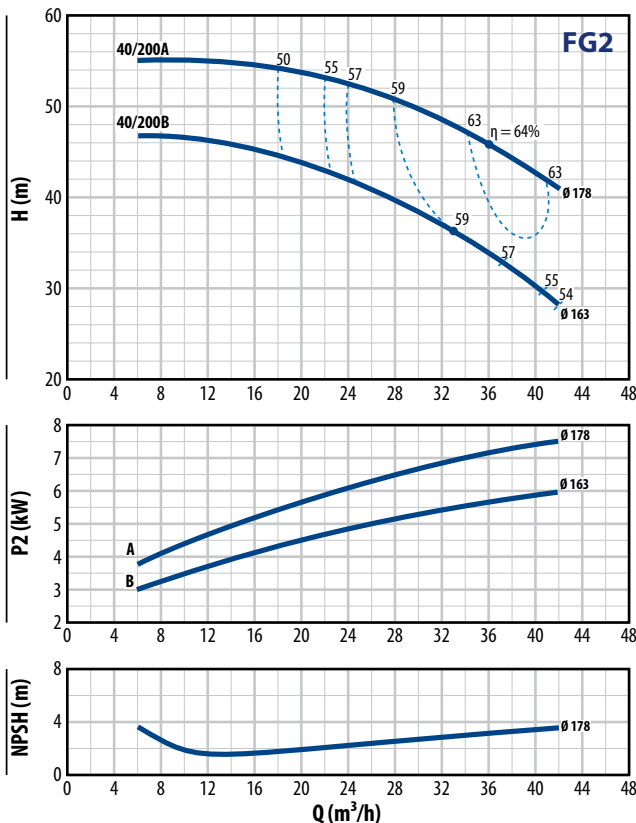

FG2-40/250

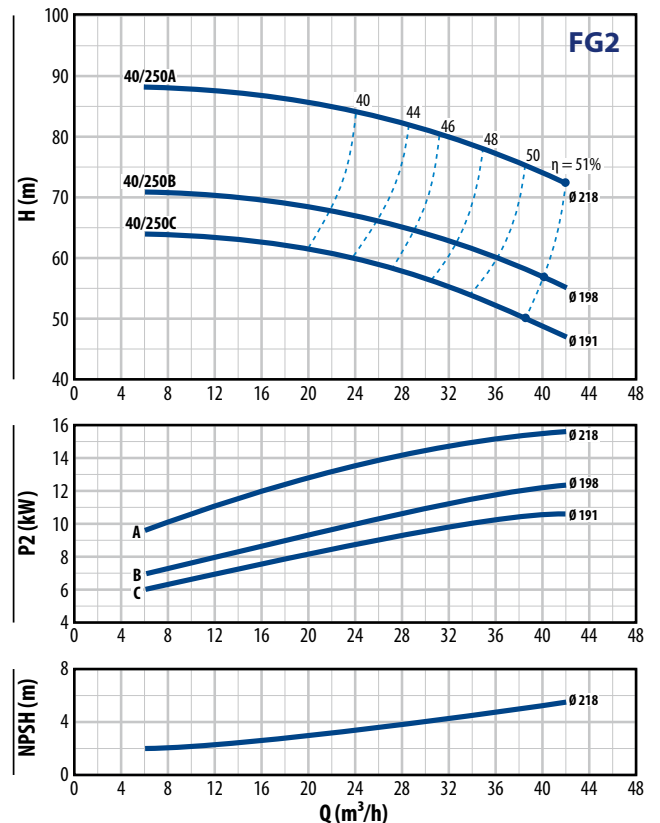

FG2-50/125

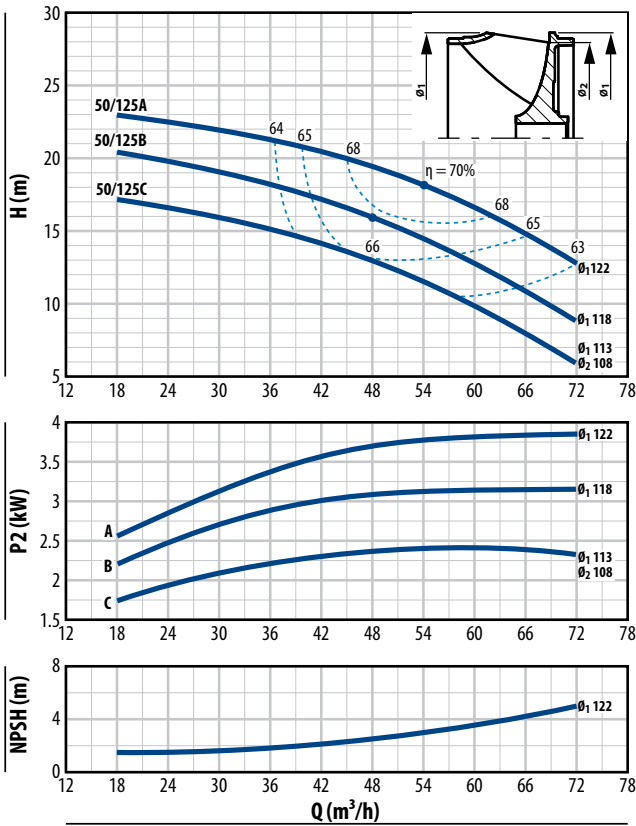

FG2-50/160

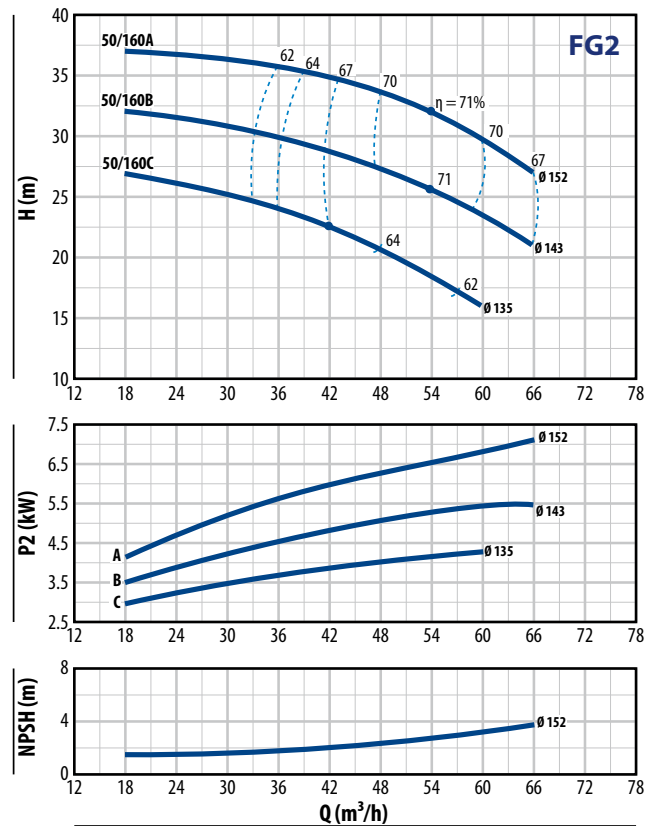

FG2-50/200

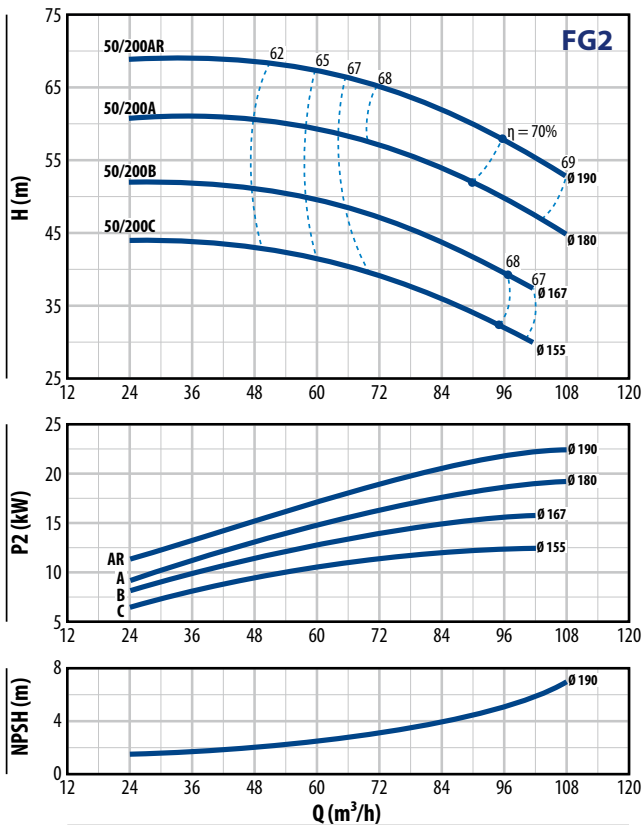

FG2-50/250

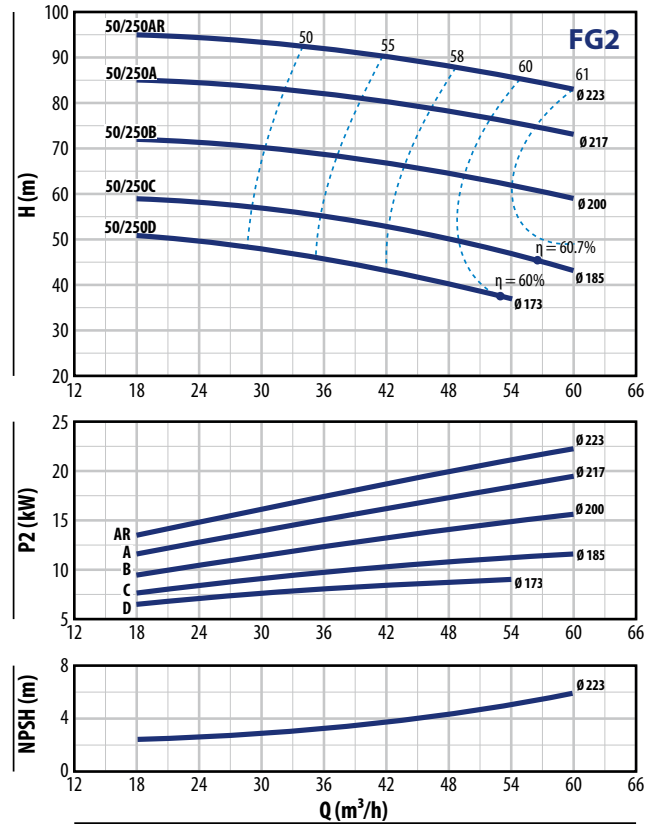

CHARACTERISTIC CURVES

n = 3450 min⁻¹

FG2-65/125

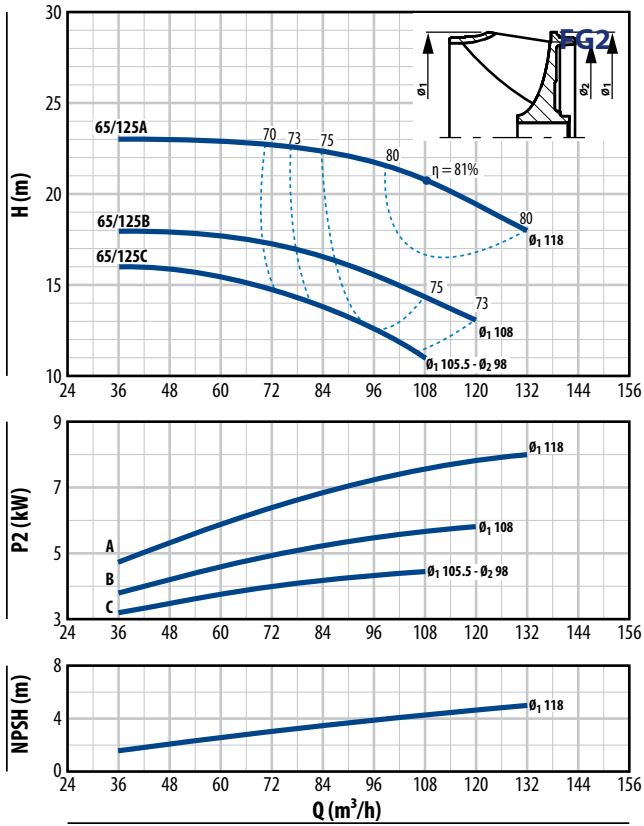

FG2-65/160

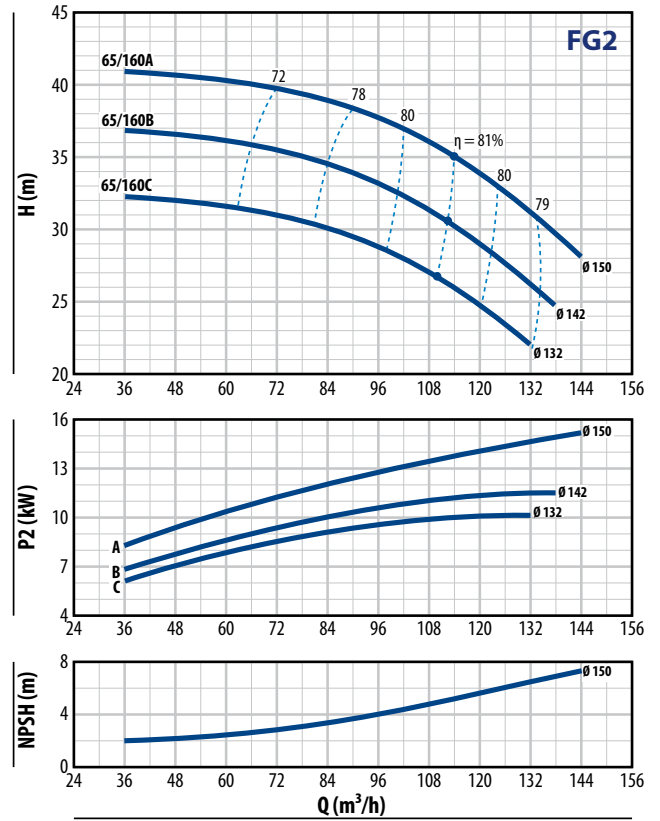

FG2-65/200

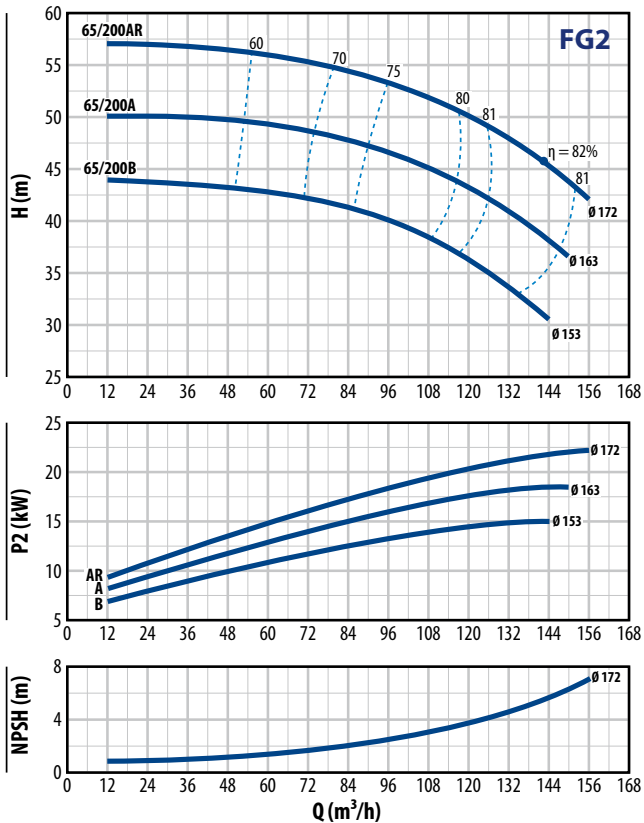

FG2-65/250

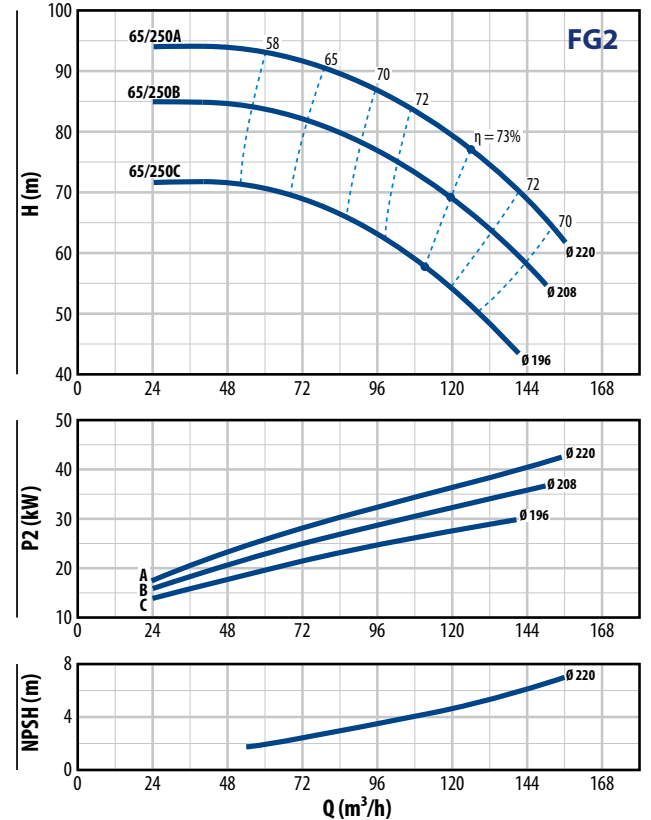

FG2-80/160

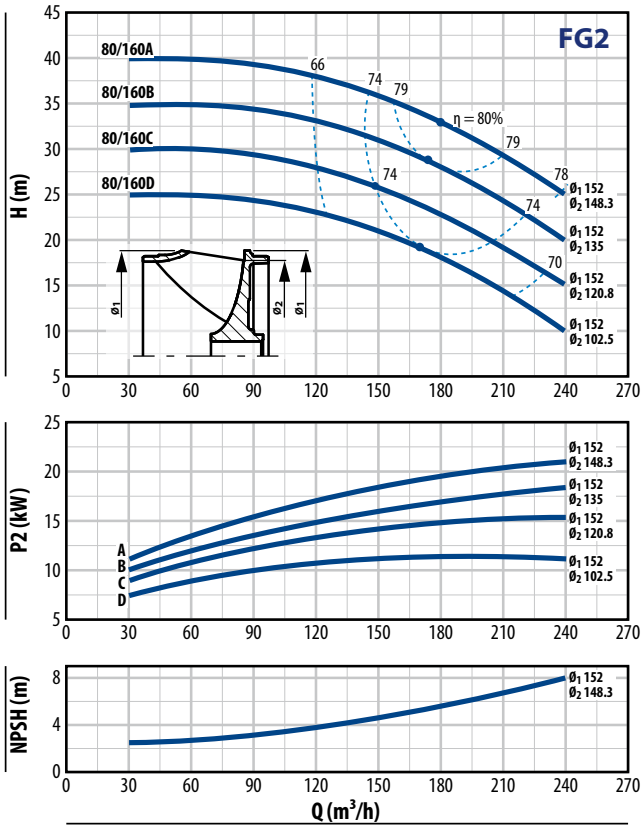

FG2-80/200

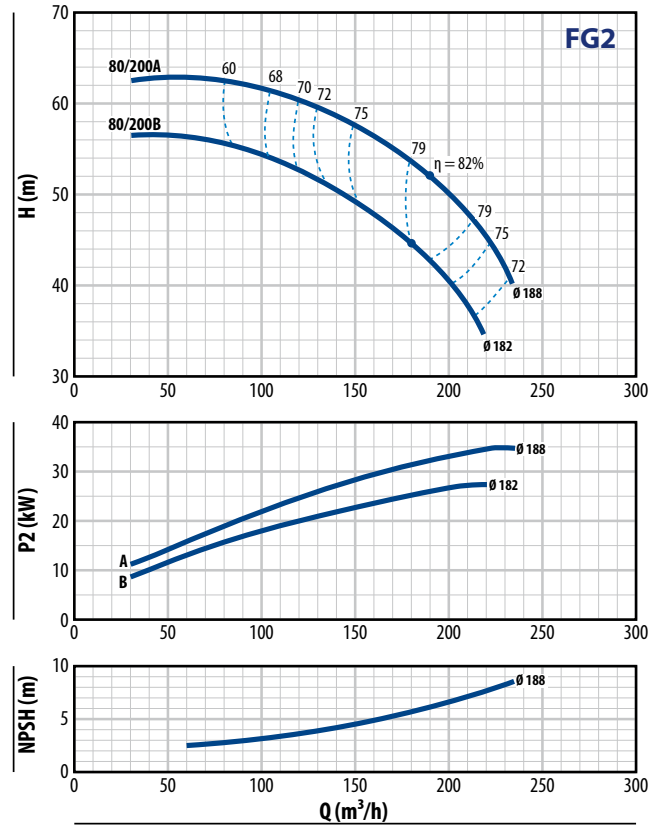

FG2-80/250

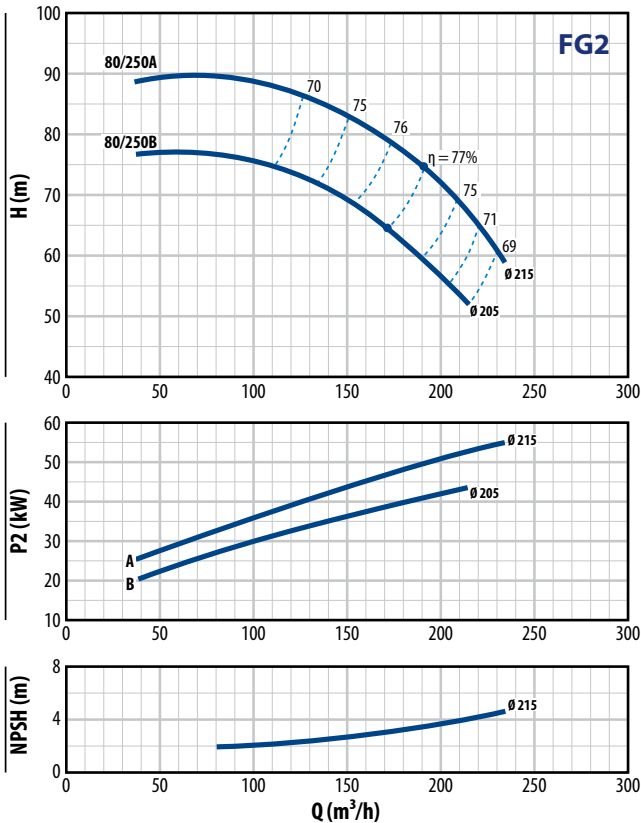

CHARACTERISTIC CURVES

n = 3450 min⁻¹

FG2-100/160

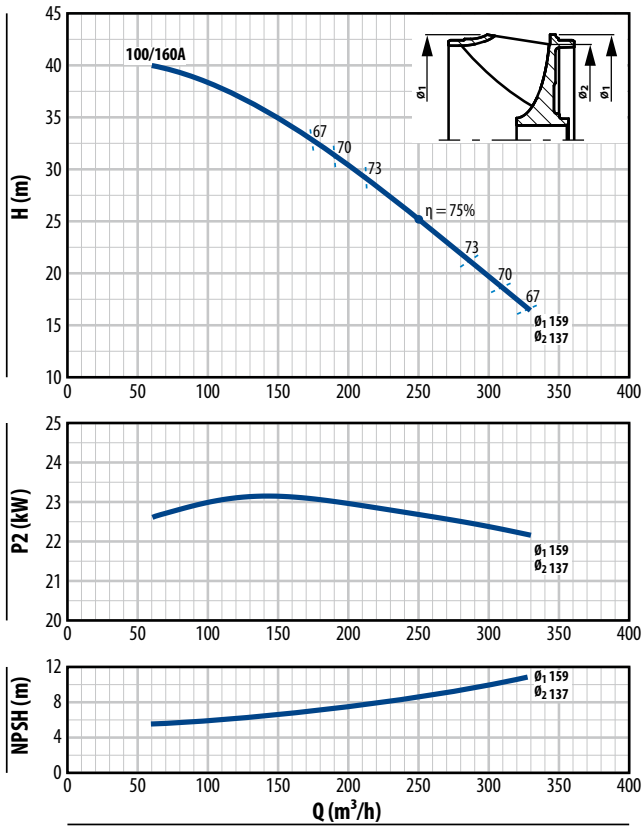

FG2-100/200

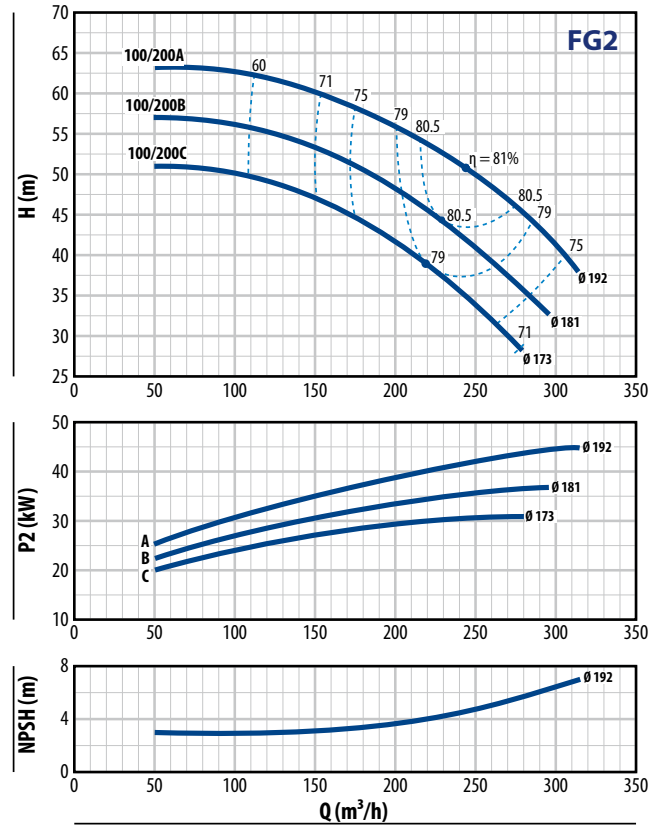

FG2-100/250

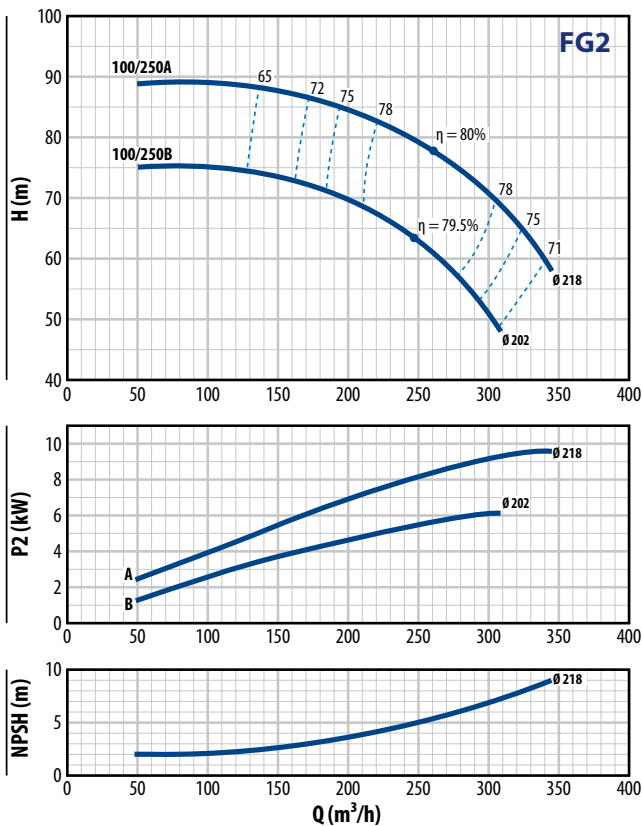

PERFORMANCE RANGE

n = 1750 min⁻¹

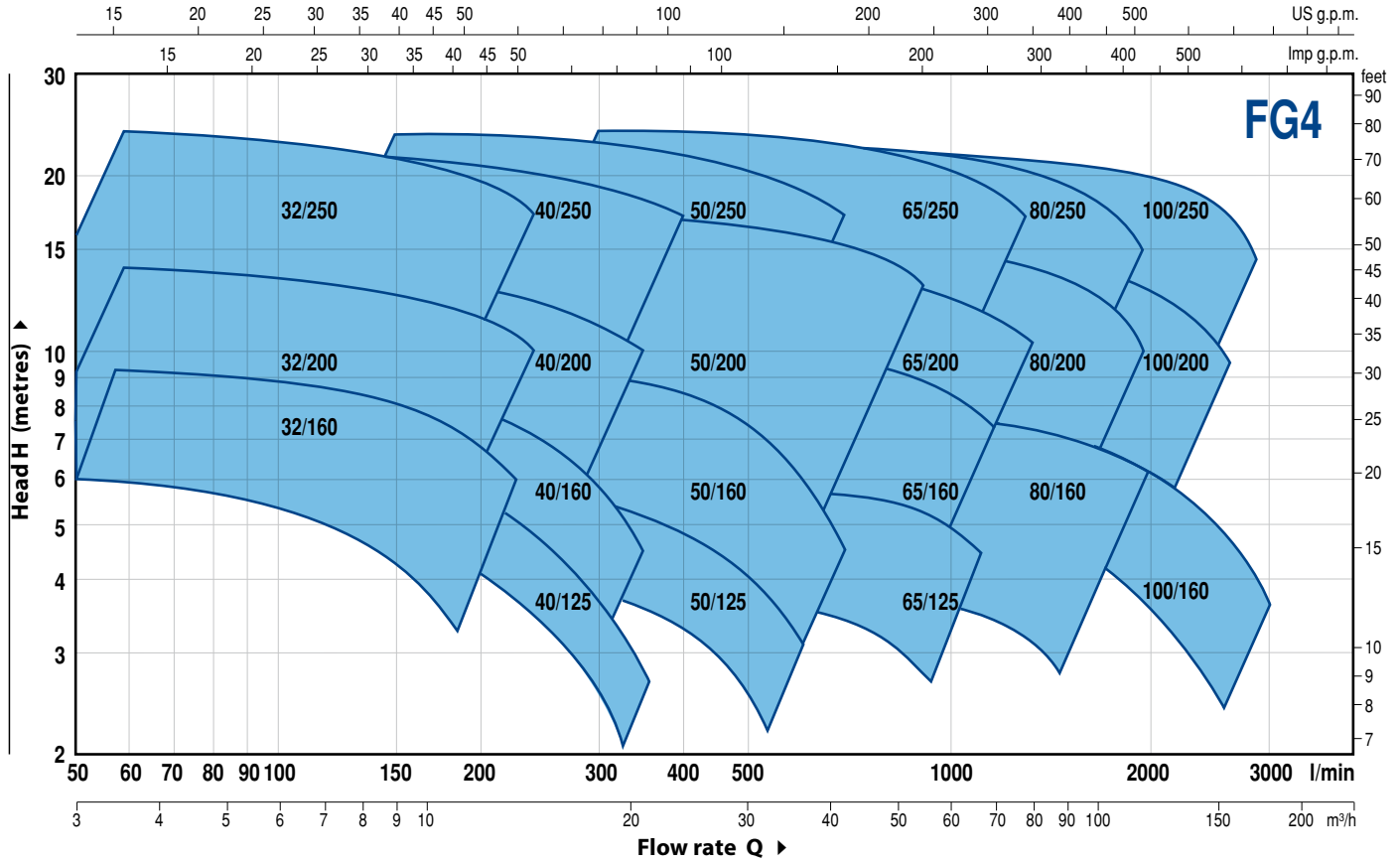

PERFORMANCE DATA

MODEL	MOTOR PAIRING		PERFORMANCE n = 1750 min ⁻¹	
	kW	HP	Q m ³ /h	H metres
FG4-32/160C	0.25	0.33	3 – 10.5	6 – 3.5
FG4-32/160B	0.37	0.5	3 – 12	7.5 – 4
FG4-32/160A	0.37	0.5	3 – 13.5	9 – 6
FG4-32/200C	0.55	0.75	3 – 13.5	11 – 8
FG4-32/200B	0.75	1	3 – 15	12.5 – 9
FG4-32/200A	1.1	1.5	3 – 15	14 – 11
FG4-32/200BH	0.55	0.75	3 – 9	11 – 9
FG4-32/200AH	0.55	0.75	3 – 9.6	13.8 – 11
FG4-32/250C	1.1	1.5	3 – 12	18.5 – 13.5
FG4-32/250B	1.5	2	3 – 13.5	21.5 – 15.5
FG4-32/250A	2.2	3	3 – 16.5	24 – 16.5
FG4-40/125C	0.18	0.25	3 – 16.5	4.1 – 1.5
FG4-40/125B	0.25	0.33	3 – 18.5	5.3 – 2.3
FG4-40/125A	0.37	0.5	3 – 21.5	6.6 – 2.5
FG4-40/160C	0.37	0.5	3 – 18	6.5 – 3.5
FG4-40/160B	0.37	0.5	3 – 18	8 – 5
FG4-40/160A	0.55	0.75	3 – 21	9.5 – 5
FG4-40/200B	0.75	1	3 – 21	11.5 – 7
FG4-40/200A	1.1	1.5	3 – 21	13.5 – 10
FG4-40/250C	1.1	1.5	3 – 21	16 – 11.5
FG4-40/250B	1.5	2	3 – 21	17.5 – 13.5
FG4-40/250A	2.2	3	3 – 21	22 – 18
FG4-50/125C	0.37	0.5	9 – 36	4 – 1.5
FG4-50/125B	0.55	0.75	9 – 36	5 – 2
FG4-50/125A	0.55	0.75	9 – 36	6 – 3
FG4-50/160C	0.55	0.75	9 – 30	7 – 4
FG4-50/160B	0.75	1	9 – 33	8 – 5
FG4-50/160A	1.1	1.5	9 – 33	9 – 7
FG4-50/200C	1.5	2	12 – 51	11 – 7.5
FG4-50/200B	2.2	3	12 – 51	13 – 9.5
FG4-50/200A	2.2	3	12 – 54	15 – 11
FG4-50/200AR	3	4	12 – 54	17 – 13
FG4-50/250D	1.1	1.5	9 – 27	12.5 – 8
FG4-50/250C	1.5	2	9 – 27	14.5 – 10.5
FG4-50/250B	2.2	3	9 – 30	18 – 14.5
FG4-50/250A	2.2	3	9 – 30	21 – 18
FG4-50/250AR	3	4	9 – 30	24 – 21

MODEL	MOTOR PAIRING		PERFORMANCE n = 1750 min ⁻¹	
	kW	HP	Q m ³ /h	H metres
FG4-65/125C	0.55	0.75	18 – 54	4 – 2.5
FG4-65/125B	0.75	1	18 – 60	4.5 – 3
FG4-65/125A	1.1	1.5	18 – 66	5.5 – 4.5
FG4-65/160C	1.1	1.5	18 – 66	8 – 5.5
FG4-65/160B	1.5	2	18 – 72	9 – 5.5
FG4-65/160A	2.2	3	18 – 72	10 – 7
FG4-65/200B	2.2	3	6 – 72	10.5 – 7.3
FG4-65/200A	2.2	3	6 – 75	12 – 8.5
FG4-65/200AR	3	4	6 – 78	14 – 10
FG4-65/250C	3	4	12 – 70.5	19 – 13
FG4-65/250B	4	5.5	12 – 75	21.5 – 15.5
FG4-65/250A	5.5	7.5	12 – 78	23.5 – 17
FG4-80/160D	1.5	2	15 – 120	6 – 2.5
FG4-80/160C	2.2	3	15 – 120	7.5 – 3.5
FG4-80/160B	2.2	3	15 – 120	8.5 – 5
FG4-80/160A	3	4	15 – 120	10 – 6
FG4-80/200B	4	5.5	15 – 109.5	14 – 8.5
FG4-80/200A	5.5	7.5	15 – 117	15.5 – 10
FG4-80/250B	5.5	7.5	18 – 108	19 – 13.5
FG4-80/250A	7.5	10	18 – 117	22 – 15
FG4-100/160A	3	4	24 – 180	8.8 – 3.8
FG4-100/200C	4	5.5	24 – 139.5	12.5 – 7
FG4-100/200B	5.5	7.5	24 – 147	14 – 8
FG4-100/200A	5.5	7.5	24 – 157.5	15.5 – 9.5
FG4-100/250B	7.5	10	24 – 154.5	18.5 – 12
FG4-100/250A	9.2	12.5	24 – 172.5	22 – 14.5

Q = Flow rate

H = Total manometric head

Tolerance of characteristic curves in compliance with EN ISO 9906 Grade 3B.

CHARACTERISTIC CURVES

$n = 1750 \text{ min}^{-1}$

FG4-32/160

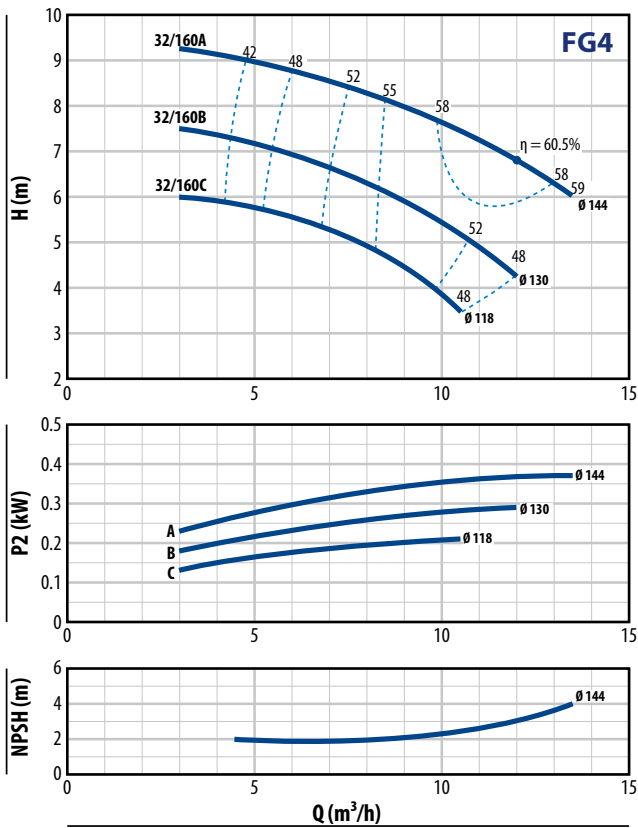

FG4-32/200

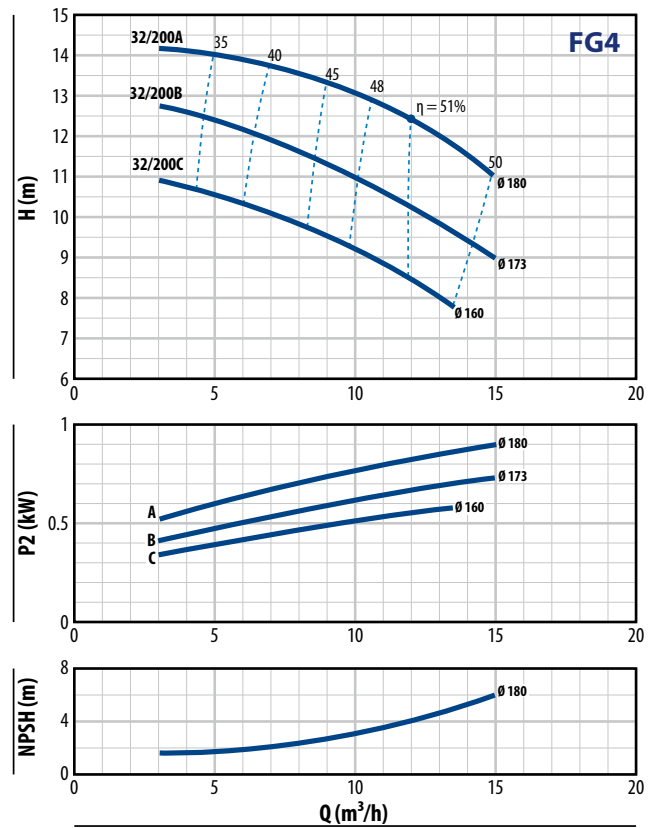

FG4-32/200H

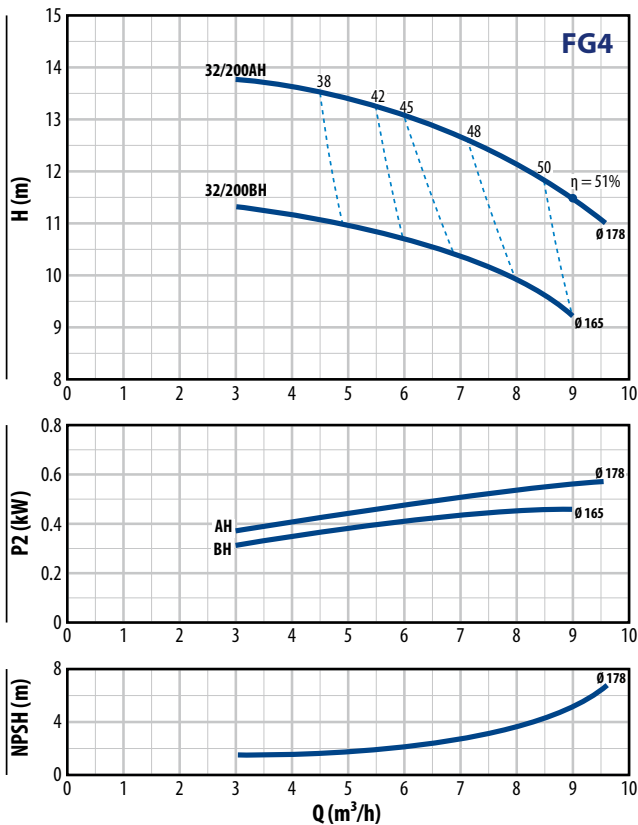

FG4-32/250

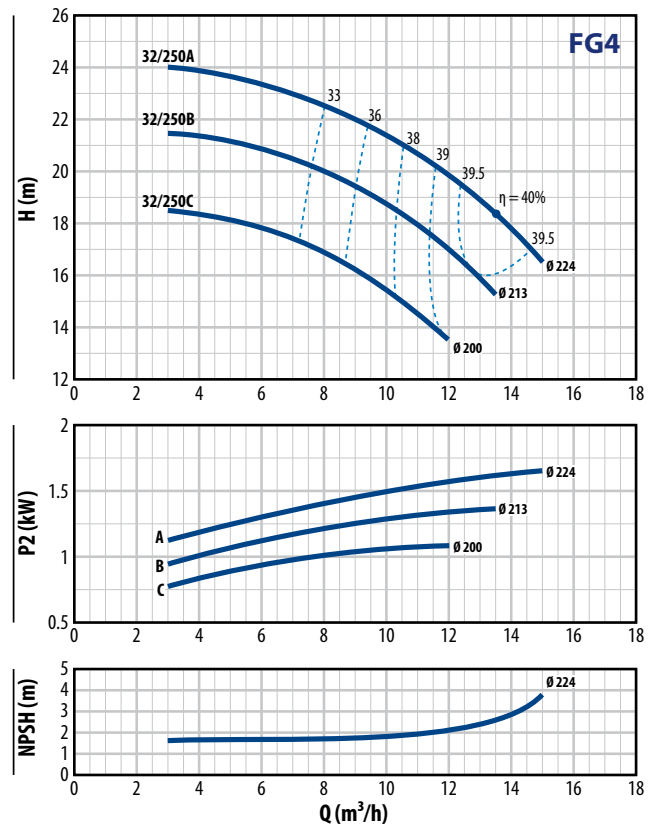

FG4

CHARACTERISTIC CURVES

$n = 1750 \text{ min}^{-1}$

FG4-40/125

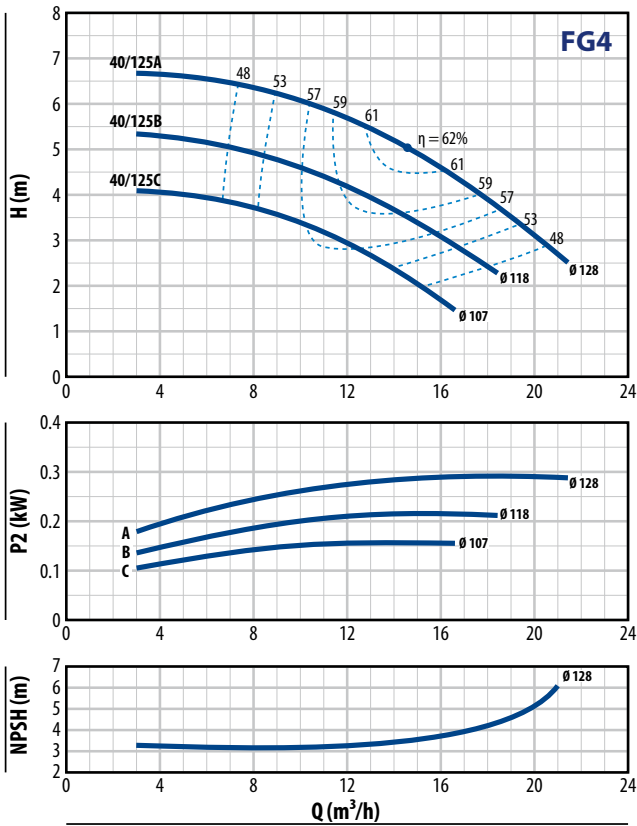

FG4-40/160

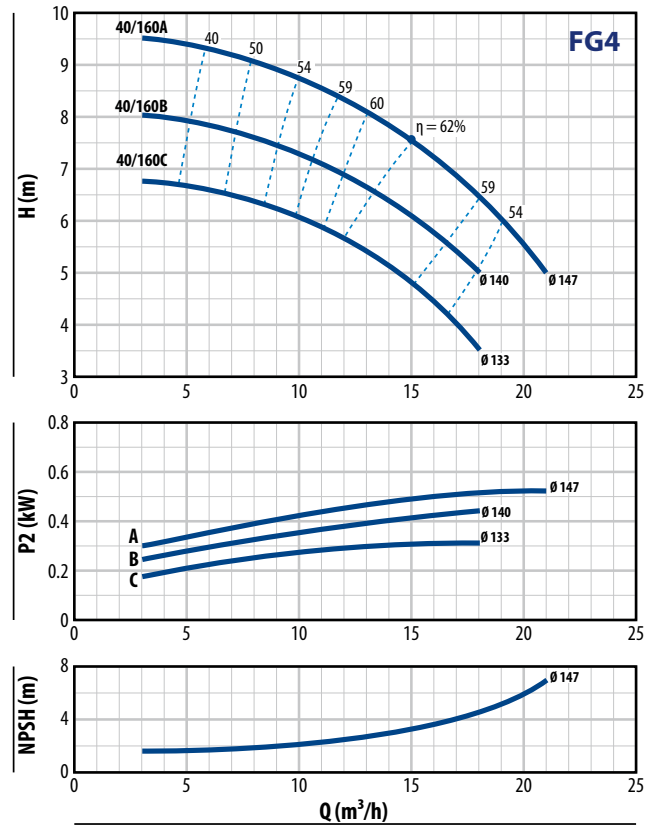

FG4-40/200

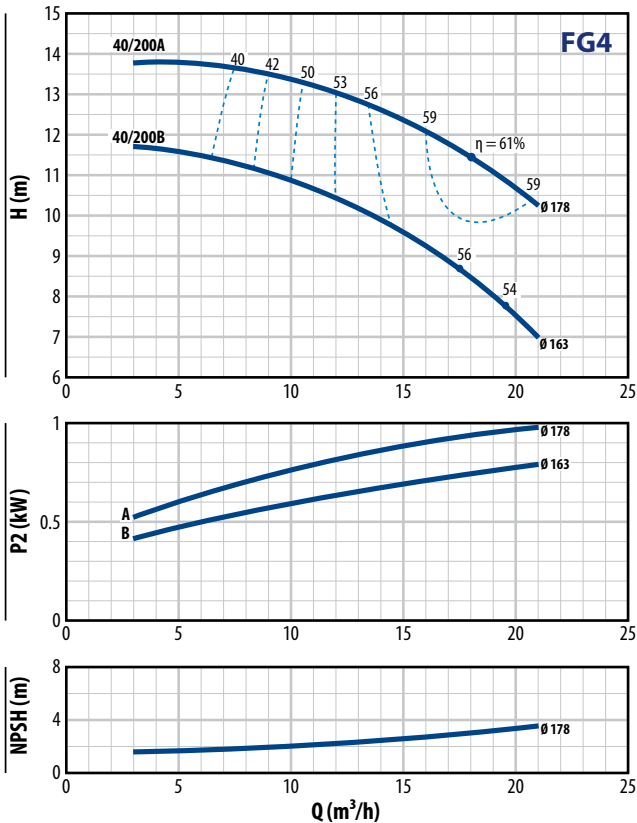

FG4-40/250

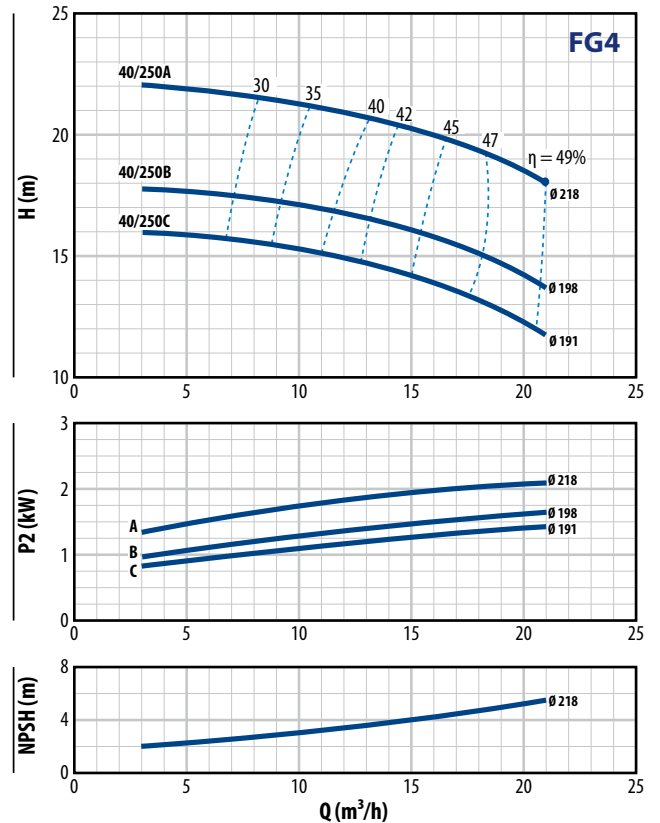

CHARACTERISTIC CURVES

$n = 1750 \text{ min}^{-1}$

FG4-50/125

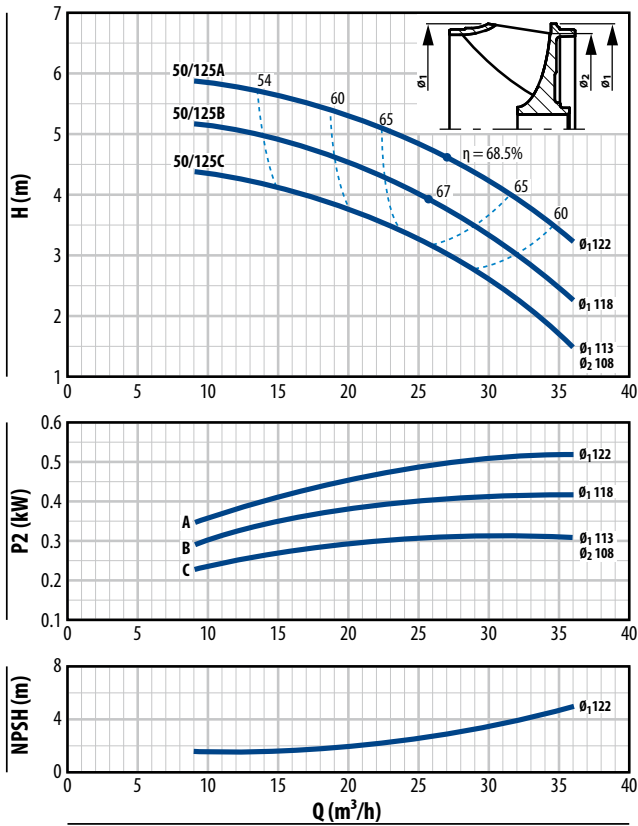

FG4-50/160

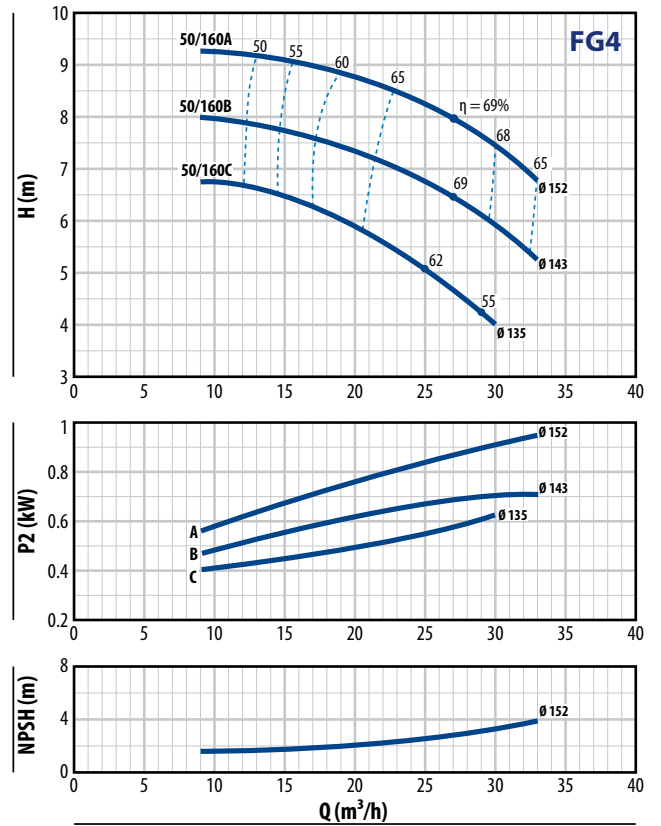

FG4-50/200

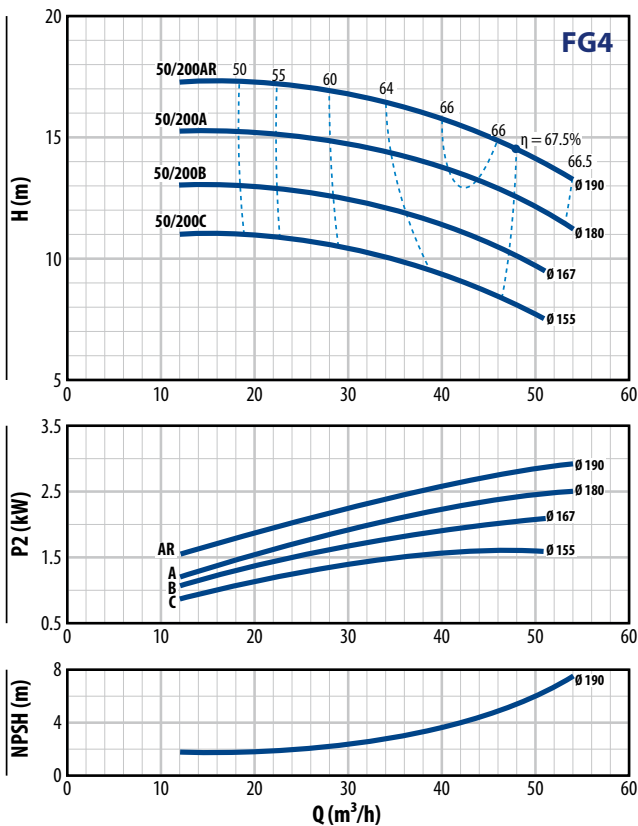

FG4-50/250

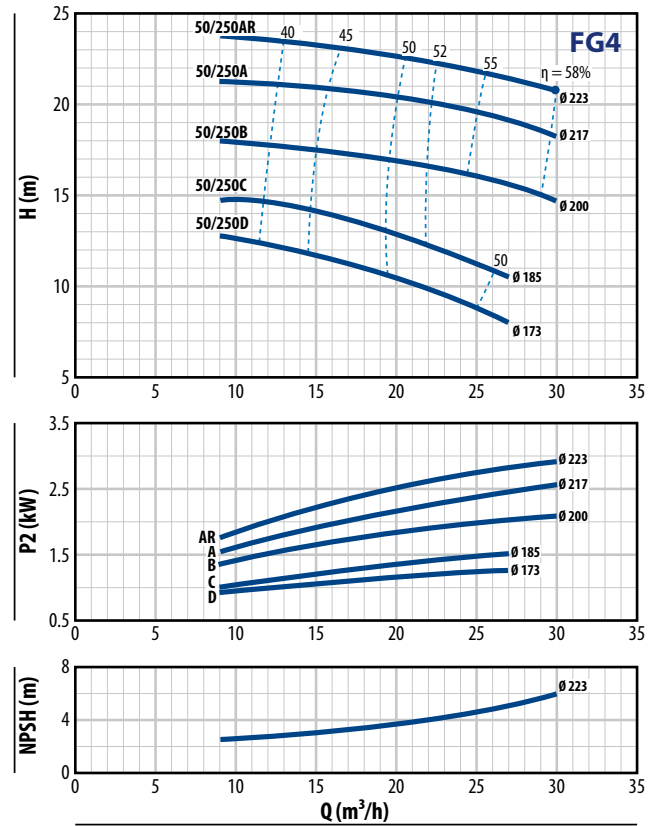

FG4

CHARACTERISTIC CURVES

$n = 1750 \text{ min}^{-1}$

FG4-65/125

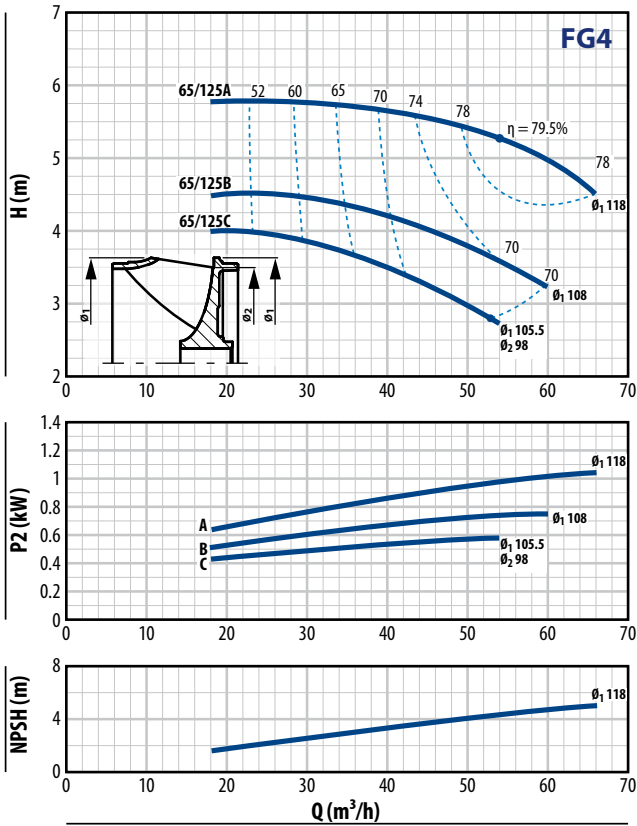

FG4-65/160

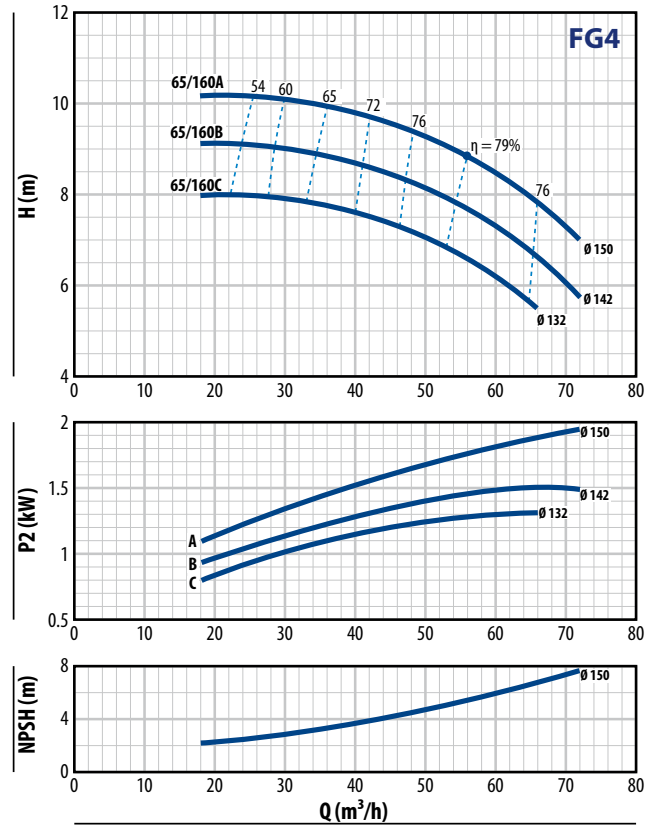

FG4-65/200

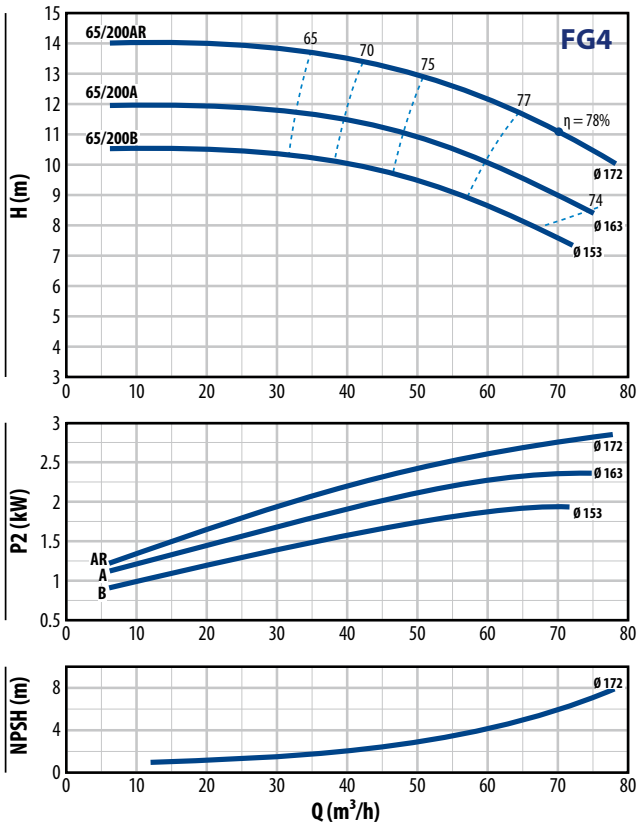

FG4-65/250

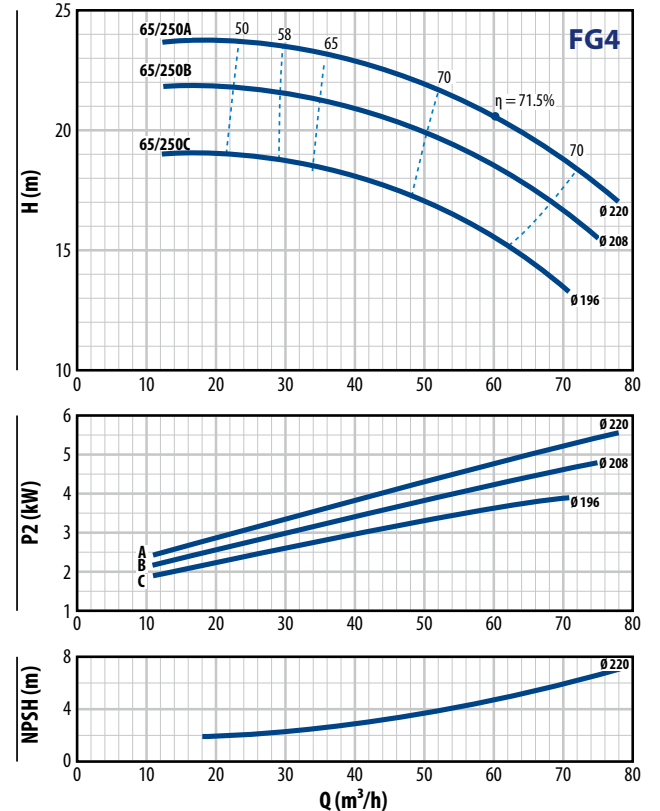

CHARACTERISTIC CURVES

$n = 1750 \text{ min}^{-1}$

FG4-80/160

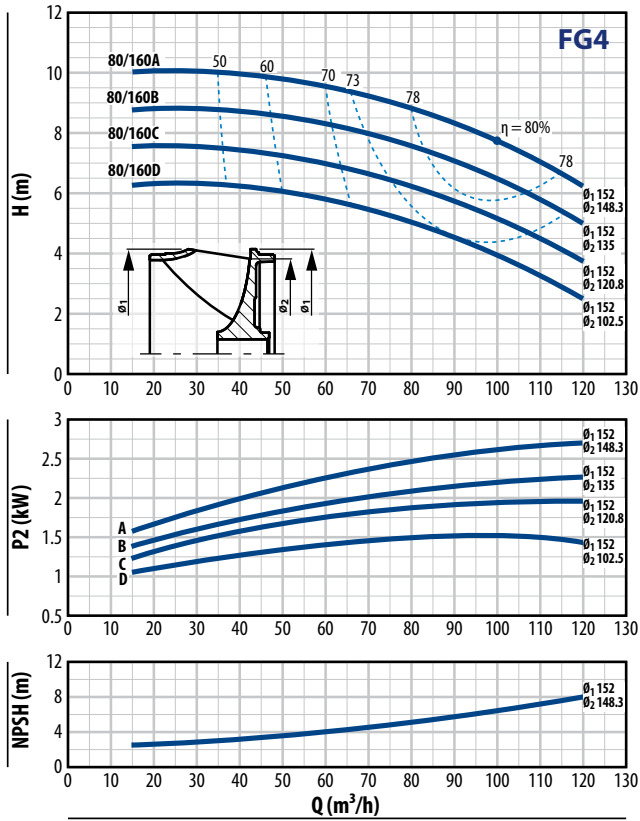

FG4-80/200

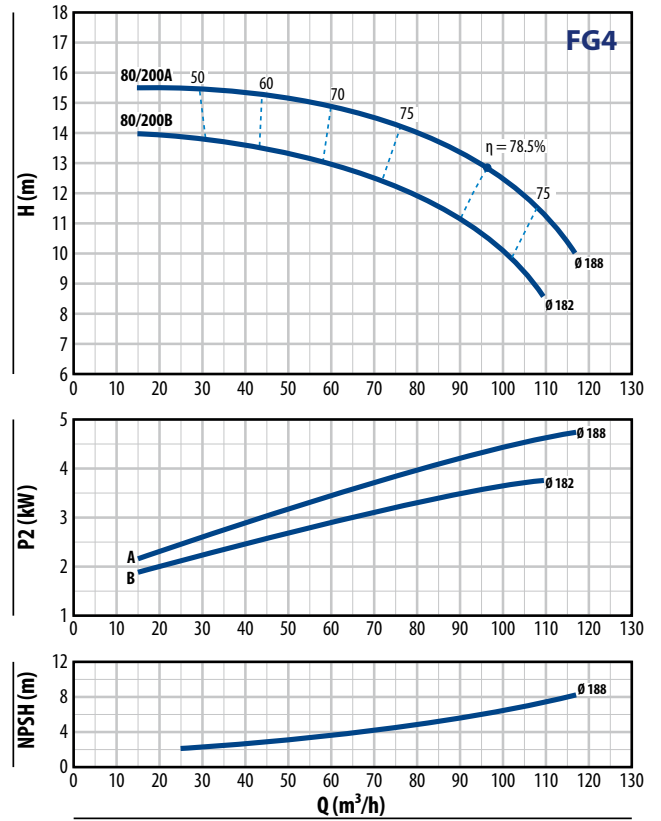

FG4-80/250

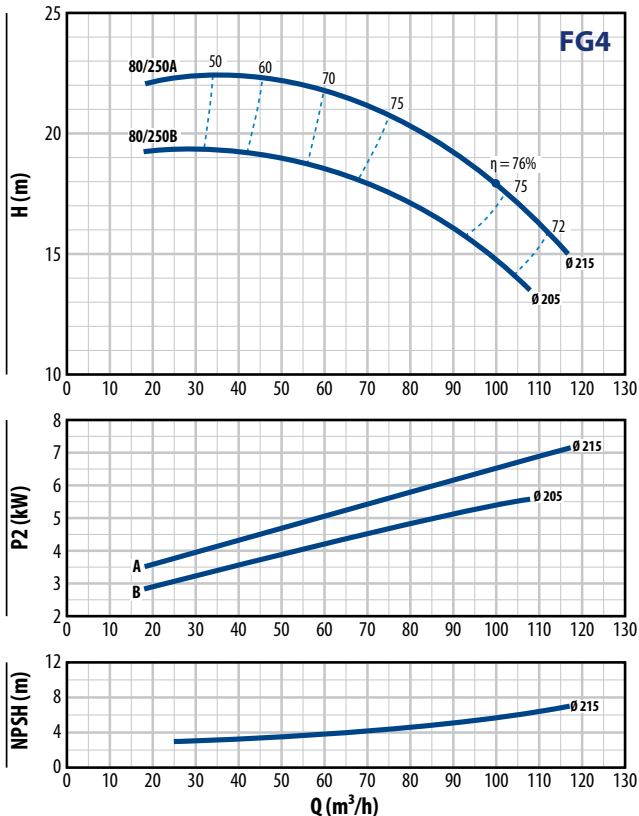

FG4

CHARACTERISTIC CURVES

$n = 1750 \text{ min}^{-1}$

FG4-100/160

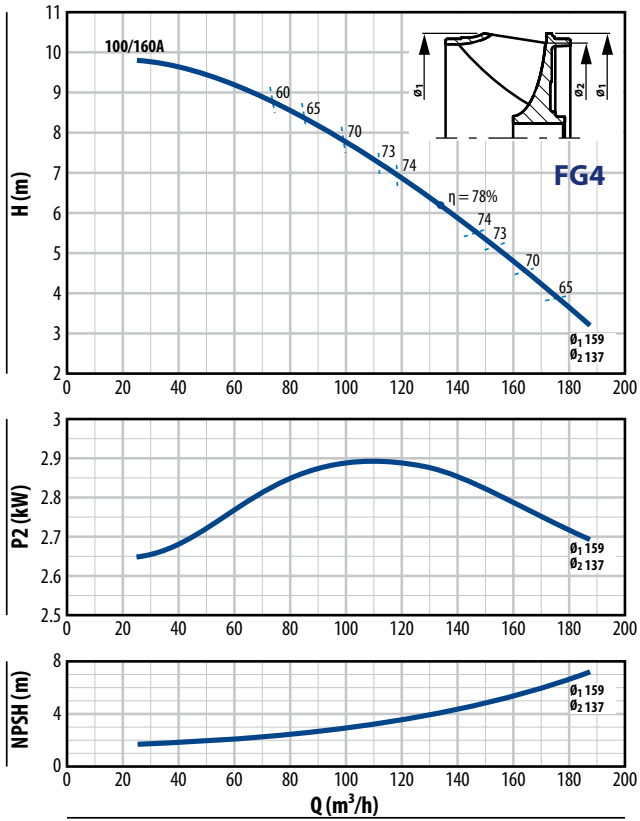

FG4-100/200

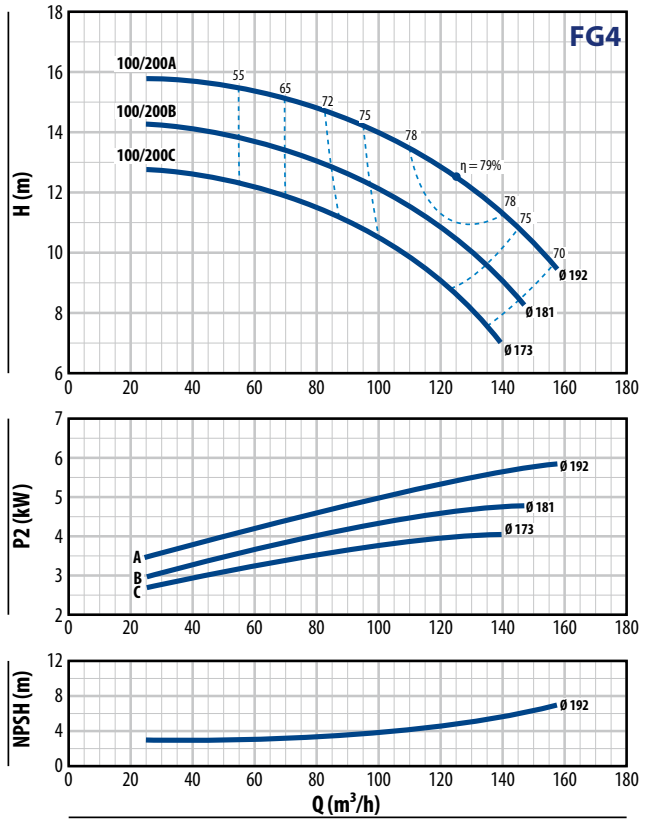

FG4-100/250

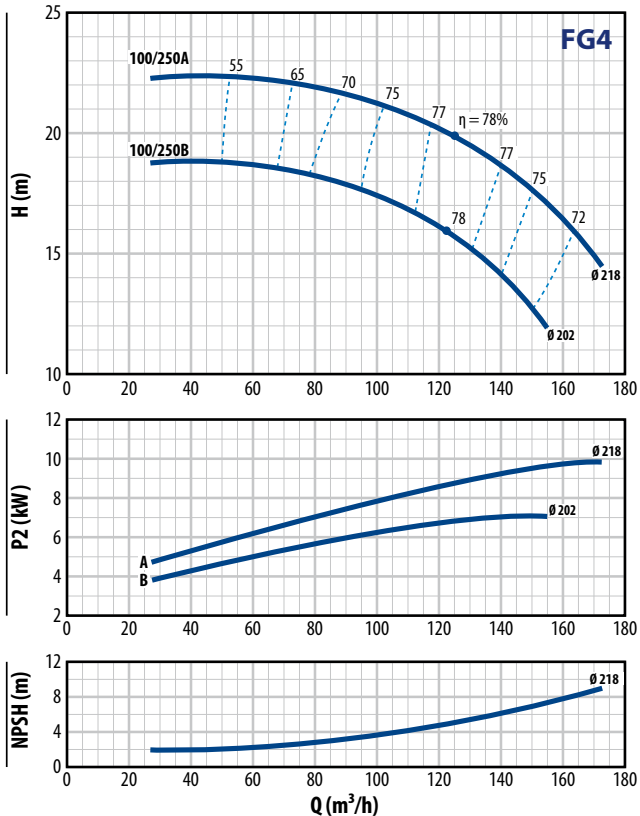

DIMENSIONS AND WEIGHT

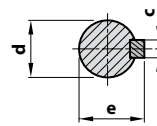
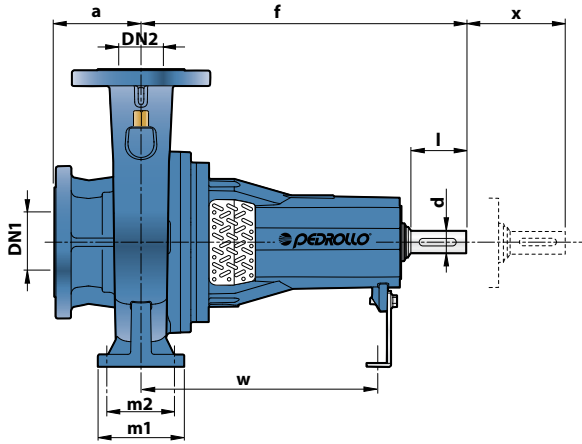

SHAFT mm		
d	c	e
24 k6	8	27
32 k6	10	35

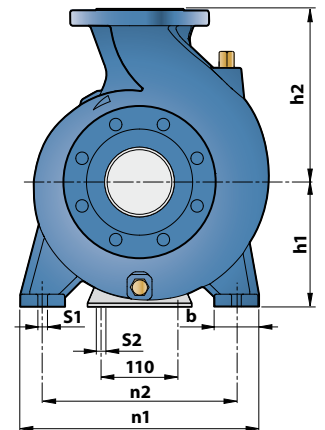

MODEL	DIMENSIONS mm																kg							
	DN1	DN2	a	f	h1	h2	b	m1	m2	n1	n2	s1	s2	w	x	d		l						
FG 32/160	50	32	80	360	132	160	55	96	71	240	190	14	14	260	100	24	50	33.0						
FG 32/200					160	180	55	95											320	250	59.0			
FG 32/200H					160	180	55	125											95	320	250	36.8		
FG 32/250	65	40	80	360	180	225	65	125	95	320	250	14	14	260	100	24	50	53.0						
FG 40/125					112	140	50	100	70	210	160								34.0					
FG 40/160					132	160	50	100	70	240	190								35.0					
FG 40/200	65	40	80	360	160	180	55	125	95	320	250	14	14	260	100	24	50	40.0						
FG 40/250					180	225	65	125	95	320	250								59.0					
FG 50/125					132	160	50	100	70	240	190								33.0					
FG 50/160	65	50	100	360	160	180	55	100	70	265	212	14	14	260	100	24	50	38.3						
FG 50/200					160	200	50	100	70	265	212								50.3					
FG 50/250					180	225	65	125	95	320	250								57.0					
FG 65/125	80	65	100	360	160	180	65	125	95	280	212	14	14	260	100	24	50	45.0						
FG 65/160					160	200	65	125	95	320	250								48.0					
FG 65/200					180	225	65	125	95	320	250								55.0					
FG 65/250	100	80	125	360	470	200	250	80	160	120	360	280	18	340	140	32	80	83.0						
FG 80/160					360	180	225	65	125	95	320	250	14						260	24	50	53.0		
FG 80/200					470	180	250	65	125	95	345	280	14						340	32	80	75.0		
FG 80/250	100	80	125	360	200	280	80	160	120	400	315	18	18	260	140	24	50	93.0						
FG 100/160					360	200	280	80	160	120	360								280	18	340	24	50	94.0
FG 100/200					200	280	80	160	120	360	280								18	340	32	80	87.0	
FG 100/250	125	100	140	470	225	280	80	160	120	400	315	18	18	340	140	32	80	104.0						

FLANGED PORTS

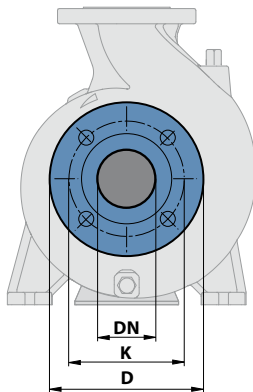

COUNTER FLANGES

(CAN BE ORDERED SEPARATELY)

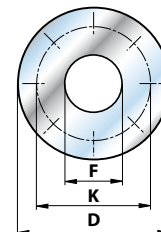

DN FLANGES mm	D mm	K mm	HOLES	
			N°	Ø (mm)
32	140	100	4	18
40	150	110		
50	165	125		
65	185	145		
80	200	160		
100	220	180	8	18
125	250	210		

DN FLANGES mm	F COUNTER FLANGES	D mm	K mm	HOLES	
				N°	Ø (mm)
32	1 1/4"	140	100	4	18
40	1 1/2"	150	110		
50	2"	165	125		
65	2 1/2"	185	145		
80	3"	200	160		
100	4"	220	180	8	18
125	5"	250	210		